

Wi-AP215

1. Packing Content

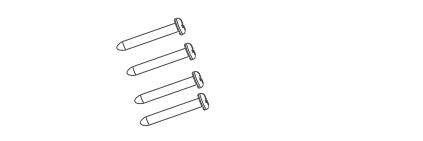

1 x AP



4 x Plastic Anchor

4 x Self-Tapping Screws



1 x Ethernet Cable

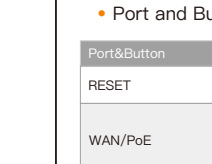

1 x Quick Installation Guide

2. Appearance Overview

• WI-AP215

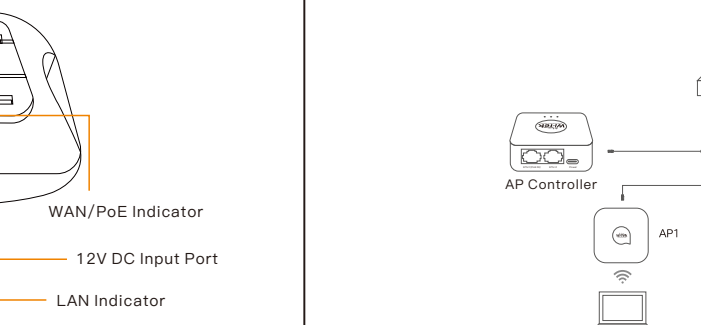

• LED indicator

LED Indicators	Status	Description
System Indicator	Red light	The system is starting.
	Yellow light	The system is restoring factory.
	Yellow	The system is working normally.
LAN Indicator	Off	The LAN port is disconnected.

• Port and Button

Port&Button	Description
RESET	Reset button, which is used to restore the factory. Holding down the reset button for 10 seconds to revert to factory settings.
WAN/PoE	10/100Mbps Base-T Ethernet Port, which supports 802.3af PoE Input. If the AP is powered through PoE, please connect this port to the PoE switch supporting 802.3af output. It is generally connected to the upstream switch.
LAN	10/100Mbps Base-T Ethernet port. It is generally connected to wired LAN devices such as PC.
DC	DC Input: 12V, 1.5A. The AP is powered through 12V DC input.

3. Typical Connection

• Bypass mode topology

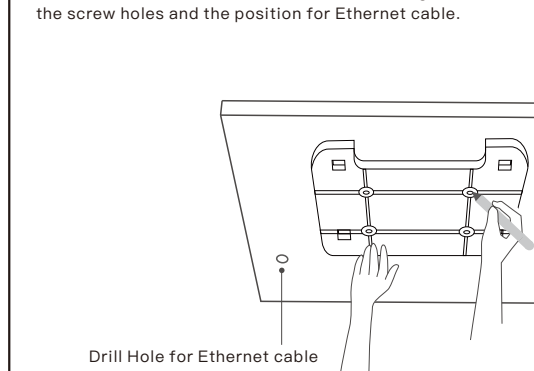

• AC Gateway mode topology

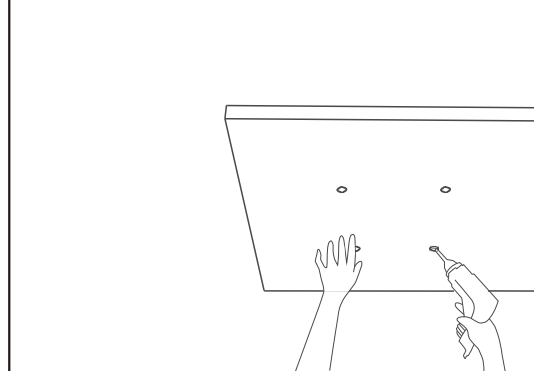

4. Device Installation

• Ceiling Mounting

- 1. Place the bracket in the center of the ceiling and then mark the positions for the screw holes and the position for Ethernet cable.

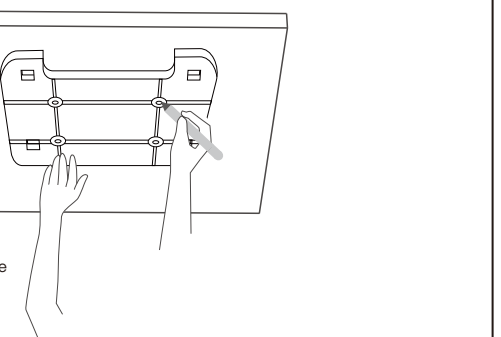

- 2. Drill holes in the marked positions using a hammer drill

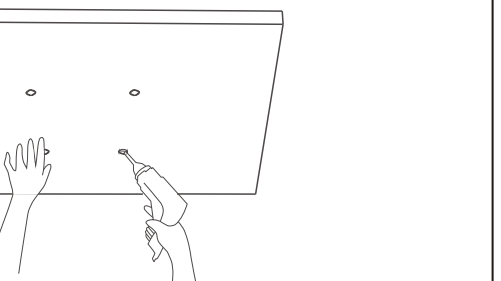

- 3. Knock the plastic anchors into the holes by using the rubber hammer. Align the screw holes in the bracket with the holes in the ceiling and use the self-tapping screws to fix the bracket.

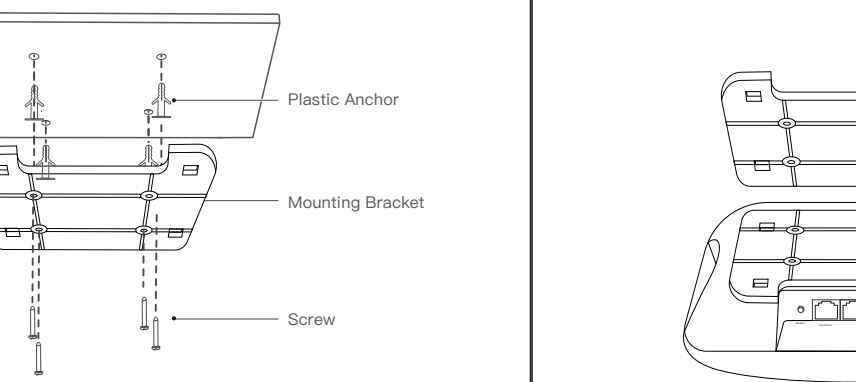

- 4. Power the AP by connecting a PoE switch to the WAN/PoE port or a power adapter to the DC Input port.

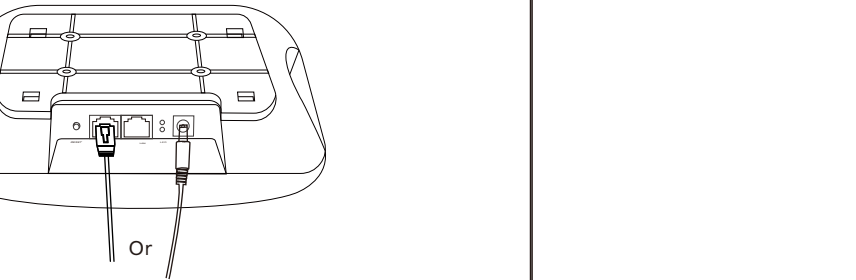

5. Power Supply

• Power via PSE Device

- The APs can be powered via PoE switch which supports 802.3af PoE output.

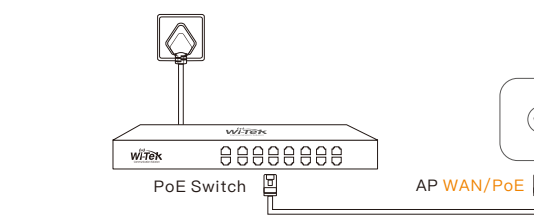

• Power via Power adapter

- Some APs can be powered via power adapter which supports 12V DC output.

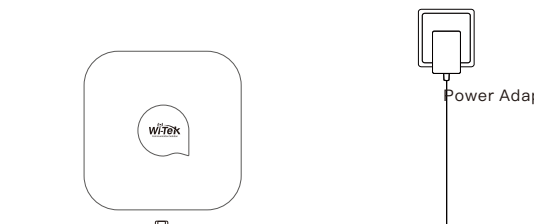

6. Configuration Method

Method 1. Connect computer to the wireless signal of AP, the default SSID is "Wi-Tek xxxx". Password is 88888888

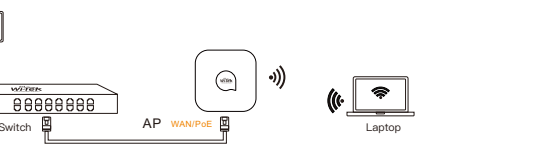

Method 2. Connect computer to the AP by Ethernet cable.

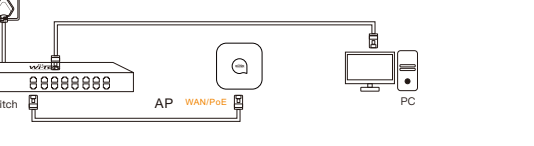

- Step 1. On the computer, please set the static IP under the same subnet with AP, 192.168.1.xx

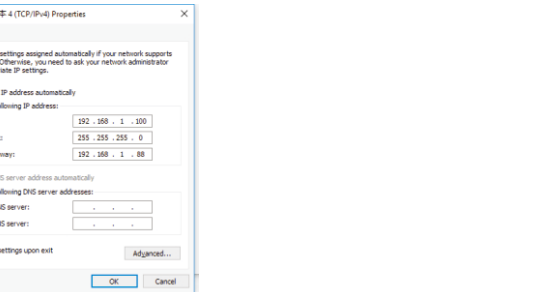

- Step 2. Please launch a browser such as Google Chrome or Firefox, type 192.168.1.88 into address bar and click on enter to get in the login page of wireless access point. The default login password is "admin".

*Login device



- Step 3. After get in the management page, On the left side menu, please go to [Wizard] to setup the access point

7. Cloud management settings

Step 1. Launch your web browser then enter http://cloud2.wireless-tek.com in the address bar. Step 2 Register an account password by user name or email. Step 3 log in to the cloud account with the account password after registration.

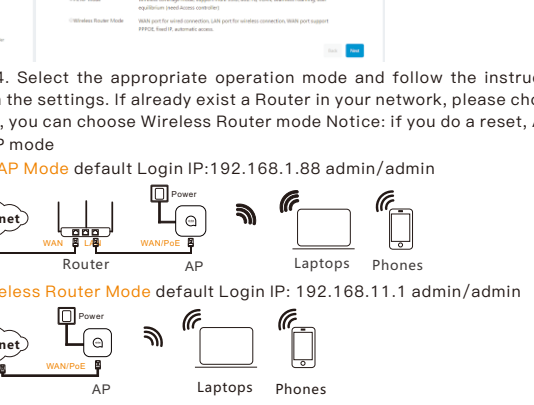

8. FAQ

Q1. The LED is not lit.

- A1: Please check the PoE switch is 802.3af/at.

Q2. What can I do if the login window does not appear?

- A1: Please check if the computer is the static IP 192.168.1.xxx.
- A2: Please try another browser.
- A3: Reboot your AP device and try again.

Q3. Disconnect the Internet connection and try again, after login, connect to the internet.

- A4: Disconnect the Internet connection and try again, after login, connect to the internet.

Warranty Card

Add EWEB

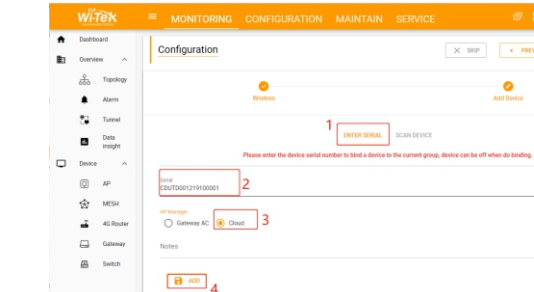

8. FAQ

Q1. The LED is not lit.

- A1: Please check the PoE switch is 802.3af/at.

Q2. What can I do if the login window does not appear?

- A1: Please check if the computer is the static IP 192.168.1.xxx.
- A2: Please try another browser.
- A3: Reboot your AP device and try again.

Q3. Disconnect the Internet connection and try again, after login, connect to the internet.

- A4: Disconnect the Internet connection and try again, after login, connect to the internet.

8. FAQ

- A1: Please check if the computer is the static IP 192.168.1.xxx.
- A2: Please try another browser.
- A3: Reboot your AP device and try again.

Q3. Disconnect the Internet connection and try again, after login, connect to the internet.

- A4: Disconnect the Internet connection and try again, after login, connect to the internet.

Q4. Disconnect the Internet connection and try again, after login, connect to the internet.

- A5: Disconnect the Internet connection and try again, after login, connect to the internet.

Q5. Disconnect the Internet connection and try again, after login, connect to the internet.

- A6: Disconnect the Internet connection and try again, after login, connect to the internet.

Q6. Disconnect the Internet connection and try again, after login, connect to the internet.

- A7: Disconnect the Internet connection and try again, after login, connect to the internet.

8. FAQ

- A1: Please check if the computer is the static IP 192.168.1.xxx.
- A2: Please try another browser.
- A3: Reboot your AP device and try again.

Q3. Disconnect the Internet connection and try again, after login, connect to the internet.

- A4: Disconnect the Internet connection and try again, after login, connect to the internet.

Q4. Disconnect the Internet connection and try again, after login, connect to the internet.

- A5: Disconnect the Internet connection and try again, after login, connect to the internet.

Q5. Disconnect the Internet connection and try again, after login, connect to the internet.

- A6: Disconnect the Internet connection and try again, after login, connect to the internet.

Q6. Disconnect the Internet connection and try again, after login, connect to the internet.

- A7: Disconnect the Internet connection and try again, after login, connect to the internet.

Q7. Disconnect the Internet connection and try again, after login, connect to the internet.

- A8: Disconnect the Internet connection and try again, after login, connect to the internet.

Q8. Disconnect the Internet connection and try again, after login, connect to the internet.

- A9: Disconnect the Internet connection and try again, after login, connect to the internet.

Q9. Disconnect the Internet connection and try again, after login, connect to the internet.

- A10: Disconnect the Internet connection and try again, after login, connect to the internet.

Q10. Disconnect the Internet connection and try again, after login, connect to the internet.

- A11: Disconnect the Internet connection and try again, after login, connect to the internet.

Q11. Disconnect the Internet connection and try again, after login, connect to the internet.

- A12: Disconnect the Internet connection and try again, after login, connect to the internet.

Q12. Disconnect the Internet connection and try again, after login, connect to the internet.

- A13: Disconnect the Internet connection and try again, after login, connect to the internet.

Q13. Disconnect the Internet connection and try again, after login, connect to the internet.

- A14: Disconnect the Internet connection and try again, after login, connect to the internet.

Q14. Disconnect the Internet connection and try again, after login, connect to the internet.

- A15: Disconnect the Internet connection and try again, after login, connect to the internet.

Q15. Disconnect the Internet connection and try again, after login, connect to the internet.

- A16: Disconnect the Internet connection and try again, after login, connect to the internet.

Q16. Disconnect the Internet connection and try again, after login, connect to the internet.

- A17: Disconnect the Internet connection and try again, after login, connect to the internet.

Q17. Disconnect the Internet connection and try again, after login, connect to the internet.

- A18: Disconnect the Internet connection and try again, after login, connect to the internet.

Q18. Disconnect the Internet connection and try again, after login, connect to the internet.

- A19: Disconnect the Internet connection and try again, after login, connect to the internet.

Q19. Disconnect the Internet connection and try again, after login, connect to the internet.

- A20: Disconnect the Internet connection and try again, after login, connect to the internet.

Q20. Disconnect the Internet connection and try again, after login, connect to the internet.

- A21: Disconnect the Internet connection and try again, after login, connect to the internet.

Q21. Disconnect the Internet connection and try again, after login, connect to the internet.

- A22: Disconnect the Internet connection and try again, after login, connect to the internet.

Q22. Disconnect the Internet connection and try again, after login, connect to the internet.

- A23: Disconnect the Internet connection and try again, after login, connect to the internet.

Q23. Disconnect the Internet connection and try again, after login, connect to the internet.

- A24: Disconnect the Internet connection and try again, after login, connect to the internet.

Q24. Disconnect the Internet connection and try again, after login, connect to the internet.

- A25: Disconnect the Internet connection and try again, after login, connect to the internet.

Q25. Disconnect the Internet connection and try again, after login, connect to the internet.

- A26: Disconnect the Internet connection and try again, after login, connect to the internet.

Q26. Disconnect the Internet connection and try again, after login, connect to the internet.

- A27: Disconnect the Internet connection and try again, after login, connect to the internet.

Q27. Disconnect the Internet connection and try again, after login, connect to the internet.

- A28: Disconnect the Internet connection and try again, after login, connect to the internet.

Q28. Disconnect the Internet connection and try again, after login, connect to the internet.

- A29: Disconnect the Internet connection and try again, after login, connect to the internet.

Q29. Disconnect the Internet connection and try again, after login, connect to the internet.

- A30: Disconnect the Internet connection and try again, after login, connect to the internet.

Q30. Disconnect the Internet connection and try again, after login, connect to the internet.

- A31: Disconnect the Internet connection and try again, after login, connect to the internet.

Q31. Disconnect the Internet connection and try again, after login, connect to the internet.

- A32: Disconnect the Internet connection and try again, after login, connect to the internet.

Q32. Disconnect the Internet connection and try again, after login, connect to the internet.

- A33: Disconnect the Internet connection and try again, after login, connect to the internet.

Q33. Disconnect the Internet connection and try again, after login, connect to the internet.

- A34: Disconnect the Internet connection and try again, after login, connect to the internet.

Q34. Disconnect the Internet connection and try again, after login, connect to the internet.

- A35: Disconnect the Internet connection and try again, after login, connect to the internet.

Q35. Disconnect the Internet connection and try again, after login, connect to the internet.

- A36: Disconnect the Internet connection and try again, after login, connect to the internet.

Q36. Disconnect the Internet connection and try again, after login, connect to the internet.

- A37: Disconnect the Internet connection and try again, after login, connect to the internet.

Q37. Disconnect the Internet connection and try again, after login, connect to the internet.

- A38: Disconnect the Internet connection and try again, after login, connect to the internet.

Q38. Disconnect the Internet connection and try again, after login, connect to the internet.

- A39: Disconnect the Internet connection and try again, after login, connect to the internet.

Q39. Disconnect the Internet connection and try again, after login, connect to the internet.

- A40: Disconnect the Internet connection and try again, after login, connect to the internet.

Q40. Disconnect the Internet connection and try again, after login, connect to the internet.

- A41: Disconnect the Internet connection and try again, after login, connect to the internet.

Q41. Disconnect the Internet connection and try again, after login, connect to the internet.

- A42: Disconnect the Internet connection and try again, after login, connect to the internet.

Q42. Disconnect the Internet connection and try again, after login, connect to the internet.

- A43: Disconnect the Internet connection and try again, after login, connect to the internet.

Q43. Disconnect the Internet connection and try again, after login, connect to the internet.

- A44: Disconnect the Internet connection and try again, after login, connect to the internet.

Q44. Disconnect the Internet connection and try again, after login, connect to the internet.

- A45: Disconnect the Internet connection and try again, after login, connect to the internet.

Q45. Disconnect the Internet connection and try again, after login, connect to the internet.

- A46: Disconnect the Internet connection and try again, after login, connect to the internet.

Q46. Disconnect the Internet connection and try again, after login, connect to the internet.

- A47: Disconnect the Internet connection and try again, after login, connect to the internet.

Q47. Disconnect the Internet connection and try again, after login, connect to the internet.

- A48: Disconnect the Internet connection and try again, after login, connect to the internet.

Q48. Disconnect the Internet connection and try again, after login, connect to the internet.

- A49: Disconnect the Internet connection and try again, after login, connect to the internet.

Q49. Disconnect the Internet connection and try again, after login, connect to the internet.

- A50: Disconnect the Internet connection and try again, after login, connect to the internet.

Q50. Disconnect the Internet connection and try again, after login, connect to the internet.

- A51: Disconnect the Internet connection and try again, after login, connect to the internet.

Q51. Disconnect the Internet connection and try again, after login, connect to the internet.

- A52: Disconnect the Internet connection and try again, after login, connect to the internet.

Q52. Disconnect the Internet connection and try again, after login, connect to the internet.

- A53: Disconnect the Internet connection and try again, after login, connect to the internet.

Q53. Disconnect the Internet connection and try again, after login, connect to the internet.

- A54: Disconnect the Internet connection and try again, after login, connect to the internet.

Q54. Disconnect the Internet connection and try again, after login, connect to the internet.

- A55: Disconnect the Internet connection and try again, after login, connect to the internet.

Q55. Disconnect the Internet connection and try again, after login, connect to the internet.

- A56: Disconnect the Internet connection and try again, after login, connect to the internet.

Q56. Disconnect the Internet connection and try again, after login, connect to the internet.

- A57: Disconnect the Internet connection and try again, after login, connect to the internet.

Q57. Disconnect the Internet connection and try again, after login, connect to the internet.

- A58: Disconnect the Internet connection and try again, after login, connect to the internet.

Q58. Disconnect the Internet connection and try again, after login, connect to the internet.

- A59: Disconnect the Internet connection and try again, after login, connect to the internet.

Q59.